



Coolant Heaters

DBW 2010

DBW 2020

DBW 300

Operating Instructions

WEBASTO DBW SERIES HEATERS _____ CONTENTS

Introduction

Important Information	1
General Safety Regulations and Information	3
Meaning of Warnings, Cautions and Notes	3

Description

General Description	5
Coolant Heater DBW 2010	5
Coolant Heaters DBW 2020 / 300	6

Operating Instructions

Operating your Webasto DBW Series Heater	7
Switching On	8
Switching Off	10
Engine Preheating	10
Operation with 7-Day Digital Timer	11
Setting the Digital Timer (Models 1529 & 1531)	13
7-Day Digital Timer Programming and Operating Instructions (Models 1529 & 1531)	14
Operation with 7-Day Electronic Timer Model CDN-1224	16
Timer Operation Modes (Model CDN-1224)	17

WEBASTO DBW SERIES HEATERS _____ CONTENTS

Dip Switch Programming (Model CDN-1224)	18
Timer Operation (Model CDN-1224)	23
Maintenance	
Maintenance of the Heater	25
Basic Troubleshooting	
General Information	27
Malfunctions	28
Malfunction Identification - DBW Series Heaters	29
Sequence of Events - DBW Series Heaters	30
Technical Data	
General Information	31
Heater Data	31
U 4810 and U 4846 Coolant Pump Data	32
U 4814, U 4851 and U 4852 Coolant Pump Data	33

Introduction

Important Information

- The heater must be installed according to the “Installation Instructions” and must be examined by an officially recognized, Webasto authorized installation/ servicing facility.
- When the heater is installed in vehicles used for the transportation of dangerous or inflammable goods, or in boats, the appropriate regulations must be observed.
- Webasto Thermosystems, Inc. does not recommend the installation and servicing of Webasto products by untrained, unauthorized personnel or end-users.
- Installations and servicing of Webasto products by untrained, unauthorized personnel and end-users will release Webasto Thermosystems, Inc. and Webasto authorized distributors, dealers and personnel from responsibility for damage to Webasto product or collateral property and personal injury.
- Any use, operation, installation, modification or application of the product not described in Webasto manuals, or subjecting the product to extreme or unusual conditions beyond the limits of specified performance characteristics is misuse of the product.
- Failure to comply with all operation, installation, and servicing instructions is a misuse of Webasto product. The same applies for repairs without using genuine Webasto service parts. This will void the coolant heaters “Official Marks of Conformity.”
- In the vicinity of the coolant heater, a temperature of 185 °F (85 °C) must not be exceeded under any circumstances (e.g. during body paint work). A violation of this temperature limit may cause permanent damage to the electronics.

- When checking the coolant level, proceed in accordance with the vehicle manufacturer's instructions.
- The coolant in the heating circuit of the heater must contain a minimum of 10% of a quality brand glycol based anti-freeze.
- The pressure setting of the coolant filler cap should be between 0.4 and 2 bar (6 p.s.i. and 28 p.s.i.).
- The coolant heater may only be operated within the specified operating voltage range designated by type.
- The coolant heater may only be operated with the specified fuel (Diesel 1, Diesel 2, Arctic grade, Kerosene and certain military spec. fuels).
- The operational state of the heater, i.e. an indication "On" or "Off", must be clearly visible to the operator.
- If electrical welding is to be done on the vehicle, the main positive and negative feed cables should be disconnected from the battery and securely connected to the chassis. This is necessary to protect the electronic control unit from voltage surges.

⚠ WARNING

Due to the danger of poisoning and suffocation, the heater must not be operated in enclosed areas, such as garages or workshops, without an exhaust venting system, not even if the start-up is activated by the timer or remote start device.

At filling stations and fuel depots the heater must be switched off as there is a potential danger of explosions.

Where flammable fumes or dust may build up (e.g. in the vicinity of fuel, coal, wood, cereal grain deposits or similar situations) the heater must be switched off to prevent explosions.

General Safety Regulations and Information

The general safety regulations for the prevention of accidents and relevant operating safety instructions must be observed at all times. The specific safety regulations applicable to this manual are highlighted in the individual chapters by Warnings, Cautions and Notes.

Meaning of Warnings, Cautions, and Notes

Warnings, Cautions and Notes in this manual have the following meaning:

WARNING

This heading is used to highlight that non-compliance with instructions or procedures may cause injuries or lethal accidents to personnel.

CAUTION

This heading is used to highlight that non-compliance with instructions or procedures may cause damage to equipment.

NOTE:

This heading is used to highlight and draw specific attention to information.

General Description

Coolant Heater DBW 2010

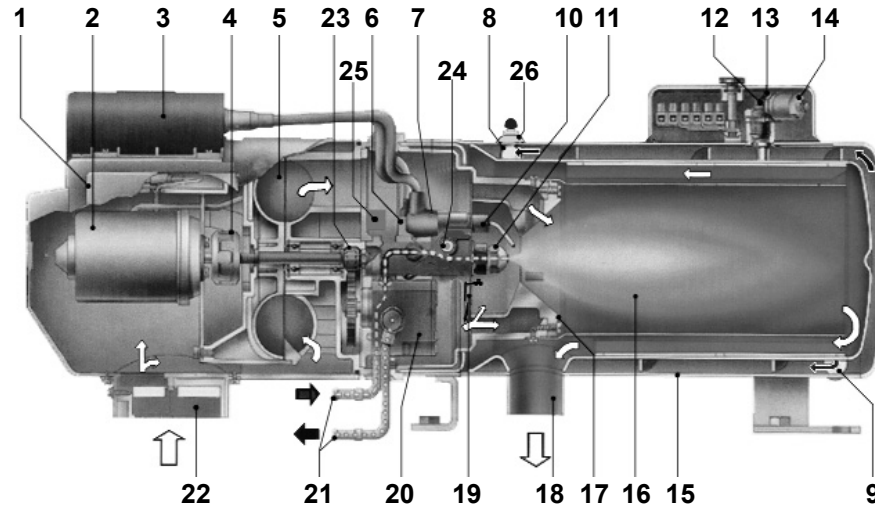

- 1 Electronic control unit
- 2 Motor
- 3 Electronic ignition coil
- 4 Coupler
- 5 Combustion air fan
- 6 Fuel solenoid valve
- 7 Electrode holder
- 8 Coolant outlet
- 9 Coolant inlet
- 10 Ignition electrodes
- 11 Fuel nozzle
- 12 Overheat fuse (white wires)
- 13 Control thermostat
- 14 Temperature limiter
- 15 Heat exchangers
- 16 Combustion chamber
- 17 Combustion air swirler
- 18 Exhaust pipe
- 19 Flame detector
- 20 Fuel pump
- 21 Fuel supply/ return pipes
- 22 Combustion air adjusting shutter
- 23 Fuel pump drive gearing
- 24 Nozzle pre-heater
- 25 Preheat thermostat (blue & green wires)
- 26 Air bleed screw

Fig. 1: Major Components of the DBW 2010 Coolant Heater

Coolant Heaters DBW 2020 / 300

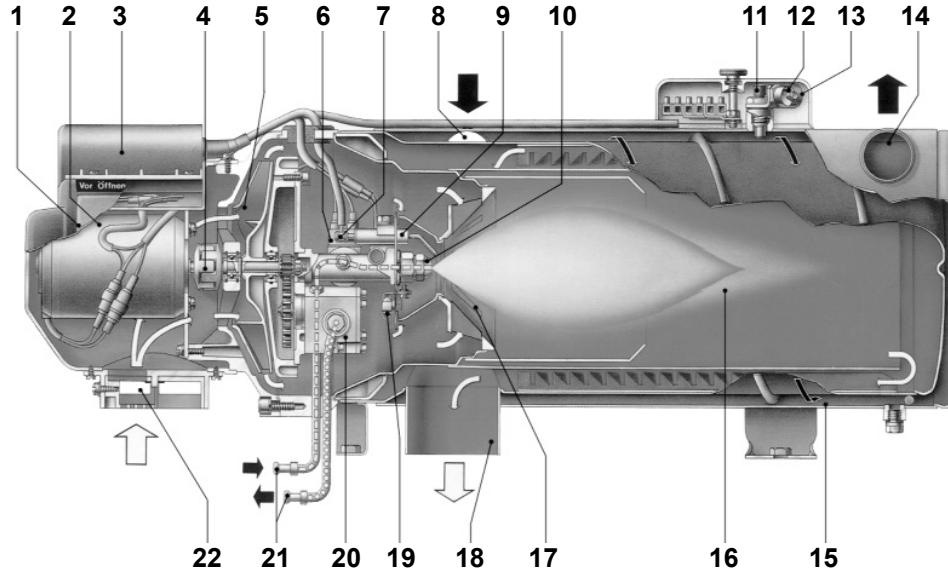

- 1 Electronic control unit
- 2 Motor
- 3 Electronic ignition coil
- 4 Coupler
- 5 Combustion air fan
- 6 Fuel solenoid valve
- 7 Electrode holder
- 8 Coolant inlet
- 9 Ignition electrodes
- 10 Fuel nozzle
- 11 Overheat fuse (white wires)
- 12 Control thermostat
- 13 Temperature limiter
- 14 Coolant outlet
- 15 Heat exchangers
- 16 Combustion chamber
- 17 Combustion air swirler
- 18 Exhaust pipe
- 19 Flame detector
- 20 Fuel pump
- 21 Fuel supply/ return pipes
- 22 Combustion air adjusting shutter

Fig. 2: Major Components of the DBW 2020 / 300 Coolant Heaters

WEBASTO DBW SERIES HEATERS _____ OPERATING INSTRUCTIONS

Operating Instructions

Operating your Webasto DBW Series Heater

⚠ WARNING

Due to the risk of carbon monoxide poisoning and asphyxiation, the heater must never be operated in closed spaces such as garages and workshops without adequate exhaust extraction.

⚠ WARNING

Due to the risk of fire or explosion, the heater must be switched off while refueling and at fueling stations.

⚠ WARNING

Due to the risk of explosion, the heater must never be operated in areas where explosive materials, fumes or dusts may be present.

WEBASTO DBW SERIES HEATERS _____ OPERATING INSTRUCTIONS

Switching On

Before switching the Webasto heater on, open any shut off valves and set vehicle heater controls to the “Hot” position. Depending on the type of control installed, the heater can be operated by the following methods.

Timer:

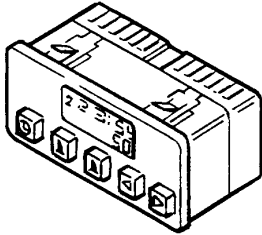

Switch:

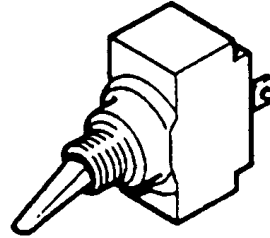

Using a Timer:

Upon pressing the “Instant Heat” button on the timer face, the “Operation Indicator” on the timer lights up and the heater begins operation.

Using a Switch:

When the switch is used for switching “ON” the Webasto heater, the “Operation Indicator” integrated in the switch is illuminated.

WEBASTO DBW SERIES HEATERS _____ OPERATING INSTRUCTIONS

Heater Start-up Sequence:

Upon switching on, an operating indicator light will illuminate.

The combustion air fan, fuel pump and circulation pump start operation. (If fitted and temperature is $< 0^{\circ}\text{C}$ ($< 32^{\circ}\text{F}$) nozzle preheating is also activated).

After approximately 15 seconds the fuel solenoid valve opens allowing fuel to flow to the nozzle where it is atomized and sprayed into the combustion chamber. At the same time, a high voltage ignition spark is generated at the electrode tips simultaneously igniting the fuel air mixture. A photo control device detects a flame in the combustion chamber and deactivates the ignition system (combustion process is self-sustaining). At this point the heater is working and producing heat.

The Webasto heater will cycle on and off until:

1. System coolant reaches operating temperature.
2. The Webasto heater is switched off.
3. Time has elapsed on the timer.
4. The vehicle battery voltage drops below 10.5V for 12 volt systems or 20.0V for 24 volt systems.
5. The Webasto heater runs out of fuel.
6. A fault lock out occurs, indicated by the operating indicator light being off during the cool down cycle (as would happen during an overheat situation).

NOTE:

If the heater is switched on while the engine is at operating temperatures above 140°F (60°C) for orange and white wire thermostat or 155°F (68°C) for red and green wire thermostat, only the operation indicator and the coolant circulation pump will be activated. Depending on the type of thermostat installed, the engine coolant temperature must fall below 140°F (60°C) or 155°F (68°C) at the heater before the heater will begin heating operation.

WEBASTO DBW SERIES HEATERS _____ OPERATING INSTRUCTIONS

Switching Off

When heating is no longer required, switch the Webasto heater off. The fuel solenoid valve interrupts the fuel supply and combustion stops. The indicator light turns off. The Combustion air fan and the water pump continue operation for approximately 150 seconds (after-run cycle) purging the combustion chamber of any fumes and cooling the heater.

NOTE:

Switching the Webasto heater on during the cool-down (after-run cycle) period is allowed. The heater will revert to normal operational mode.

Engine Preheating

1. Set the timer 10 min. to 120 min. before you want to start the engine. The heater will start up at the set time. (See timer operating instructions). Or switch the toggle switch or “Instant On” switch on your timer in the vehicle dash to “On”. The heater will start up.
2. When the run time has elapsed on your timer or engine preheating is no longer required, switch the Webasto heater “Off”. The heater will begin the after-run (cool-down) cycle.

NOTE:

Make sure all coolant and cab heater valves are open before operating the heater in the preheat mode.

WEBASTO DBW SERIES HEATERS _____ OPERATING INSTRUCTIONS

Operation with 7-Day Digital Timer (Model 1529 Shown)



The digital timer with 3 time settings permits the Webasto heater to be switched on and off instantly, or automatically at 3 programmable starting times.

The operating time of the heater can be pre-selected. It is possible to program 3 different heating times according to your individual needs.

Only one preset starting time can be activated at any one time. When the ignition is switched on, the current time of the day and the day of the week are displayed.

When the heater is in operation, the display and the buttons of the timer are illuminated.

WEBASTO DBW SERIES HEATERS _____ OPERATING INSTRUCTIONS



Programmed Heater Operation

Three memory locations numbered 1 to 3 are available. Each memory location can be assigned a given time together with the day of the week.

Pre-selected Starting Times

The pre-selected starting time is the time at which the heater will be switched on automatically. We recommend that memory locations 1 and 2 be used for presetting starting times within 24 hours of setting the timer. Memory location 3 can be used for a starting time within the next 7 days of setting the timer.

NOTE:

We recommend that memory locations 1 and 2 be used for presetting starting times within a 24 hour period of setting the timer. Memory location 3 can be reserved for a starting time within the next 7 days of setting the timer. Location 3 is useful for occasional weekend or field trip operations outside of the normal schedule. By repeatedly pressing the  button on the 1529 timer or  button on the 1531 timer, starting time program 1, 2 or 3 can be viewed and preset.

Operating Time

The period of time during which the heater is in operation is referred to as the operating time. The heater remains in operation for as long as the operating time has been preset. Heater operation can be pre-selected for any time from a minimum of 1 minutes (a minimum of 10 minutes is recommended) to a maximum of 120 minutes (factory preset is 60 minutes).

Remaining Operating Time

The remaining operating time refers to the period of time the heater still continues to remain in operation. It can only be changed while heater is in operation.

Setting the Digital Timer (Models 1529 & 1531)

After the power has been connected, all symbols on the digital display are flashing. The time of the day and the day of the week must be set.

All flashing displays and symbols of the timer can be set by means of the ◀ and ▶ buttons.

If the ◀ and ▶ buttons are not pressed within 5 seconds, the currently displayed time or function will be stored.

When the ◀ and ▶ buttons are pressed for more than 2 seconds, the quick digit advance mode is activated.

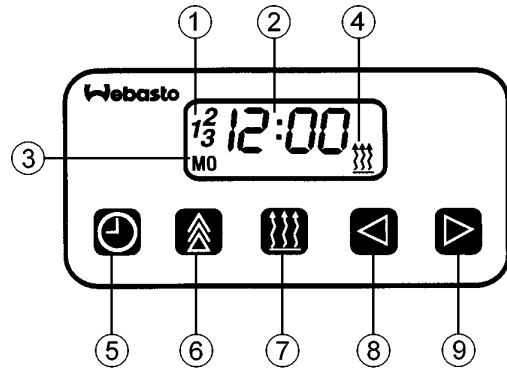

- 1 Program number for preset time.
- 2 Time of day / preset time / operating duration display.
- 3 Day of the week display.
- 4 Operation indicator.
- 5 Setting / viewing the time; setting / recalling day of the week.
- 6 Presetting / recalling starting time; setting / recalling day of the week.
Note: Timer model 1531 uses a **P** symbol for the programming key.
- 7 Heater On/Off.
- 8 Reverse key for setting time of day or heater start-up time; viewing and reducing operating duration / remaining operating time.
- 9 Forward key for setting time of day or heater start-up time; presetting day of start-up; viewing and extending operating duration / remaining operating time.

Fig. 3: 7-Day Digital Timer (Model 1529)

WEBASTO DBW SERIES HEATERS _____ OPERATING INSTRUCTIONS

7-Day Digital Timer Programming and Operating Instructions (Models 1529 & 1531)











<p>Setting the time and day of the week</p>	<p>Press the  button for more than 2 seconds. Time display flashes. Press the  or  button to set time of day. Wait 5 seconds. Time is now stored. Day of week flashes. Press  or  button to set day of week. Wait 5 seconds. Day of week is now stored.</p>
<p>Viewing the time</p>	<p>With ignition “ON”: Continuous display of current time and day of the week. With ignition “OFF”: Briefly press  button. Display of current time and weekday appears for 5 seconds.</p>
<p>Switching heater on for instant heater operation</p>	<p>With ignition “ON”: Press  button. Heater is switched on (continuous heating) and continues to operate until  button is pressed again or ignition is switched off. With ignition “OFF”: Press  button. Heater is switched on for the preset operating time (the factory-set heater operating duration is 60 minutes).</p>
<p>Switching the heater off</p>	<p>Press  button. Heater begins cool-down (after-run) cycle and is switched off thereafter.</p>

Table 1: Digital Timer Instructions

WEBASTO DBW SERIES HEATERS _____ OPERATING INSTRUCTIONS

<p>Programming heater-starting time</p>	<p>Press ▲ or P button. Memory location number flashes. Press ◀ or ▶ button to preset starting time. Wait 5 seconds. Starting time is now stored. Day of week flashes. Press ◀ or ▶ button to set day of week. Wait 5 seconds. Day of week is now stored. The number of memory location remains on the display. The timer is now in the programmed mode and switches heater on at the preset time.</p>
<p>Recalling/canceling pre-selected times</p>	<p>To recall: Press ▲ or P button until the desired memory location number is displayed. Read off preset time. To cancel: Press ▲ or P button repeatedly until the memory location numbers are no longer visible on the display.</p>
<p>Programming duration of operating time</p>	<p>The heater must be switched off. Press the ◀ button. Operating time flashes. Press ◀ or ▶ button to set operating duration time between 1 and 120 minutes (minimum 10 minutes recommended).</p>
<p>Setting the remaining operating time</p>	<p>Heater must be in operation. Press ◀ button. Remaining operating time flashes. Press ◀ or ▶ button to set remaining operating time. Wait 5 seconds. The remaining operating time is now stored.</p>

Table 1: Digital Timer Instructions (continued)

WEBASTO DBW SERIES HEATERS _____ OPERATING INSTRUCTIONS

Operation with 7-Day Electronic Timer Model CDN-1224

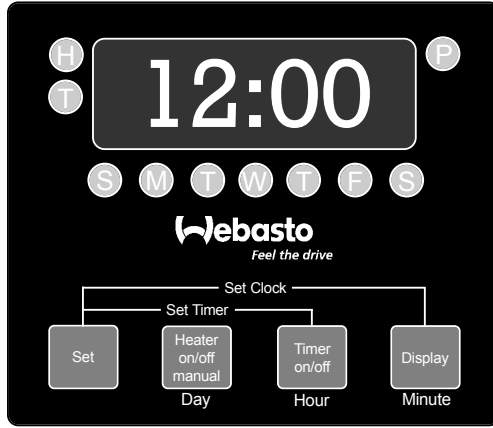

The 7-Day Electronic Timer Model CDN-1224 permits the Webasto heater to be switched on and off instantly, or automatically.

The timer allows for 1 preset start time once within a 24 hour period on any one day up to 7 days in advance.

The current time and weekday must be preset before any other programming features can be accomplished.

The 7-Day Electronic Timer is designed to operate on both 12 and 24 volt systems.

Operational characteristics of both timer and heater can be tailored to the requirements of the heating application by pre-programming of the timer.

This is normally done at the time of installation. Four dip switches located on the back panel of the timer are provided for changing the operational characteristics of the timer. These settings can be revised at any time should your heating requirements change.

⚠ CAUTION

Timer requires dismounting and disconnecting of power source before revising dip switch settings.

For complete timer installation and operation instructions, refer to the 7-Day Electronic Timer Model CDN-1224 Operating Instructions manual available from your Webasto agent under part number 907111.

WEBASTO DBW SERIES HEATERS _____ OPERATING INSTRUCTIONS

Timer Operation Modes (Model CDN-1224)

Truck or Bus Operation

By flipping one of the dip switches on the back of the unit, the timer can be set for either truck or bus operation. The tables shown below illustrates the timing sequence associated with operation in either of these modes.

Bus Application

Ignition wire is connected to ignition source and dip switch #3 is in bus mode.

Whether the heater is turned on manually or automatically, it will stay on until the timer duration ends. Except, when the heater is turned on manually while the bus is running (ignition key turned on), the heater will shut off when the ignition key is turned off, or the heater on/off button is pressed.

Truck Application for Preheat Mode Only

Ignition wire is disconnected and dip switch #3 is in truck mode.

Pre-set Mode	Heater on	Timer duration ends	Heater turns off after time duration ends
Manual Mode	Heater on	Timer duration ends	Heater turns off after time duration ends

Truck Application for Preheat and Sleeping Modes

Ignition wire is connected to constant (battery) power source and dip switch #3 is in truck mode.

Pre-set Mode	Heater on	Timer duration ends	Heater turns off after time duration ends
Manual Mode	Heater on	Unlimited duration	Heater stays on until turned off manually

WEBASTO DBW SERIES HEATERS _____ OPERATING INSTRUCTIONS

Dip Switch programming (Model CDN-1224)

Prior to installing the timer, all dip switches must be set to the requirements of your application.

The dip switches allow for setting the clock in either AM/PM mode or 24 hour (military) mode. Also included is the ability to select the desired heater run time of 30, 60, 90 or 120 minutes.

Dip switch settings are accessed through a cut out on the rear panel of the timer.

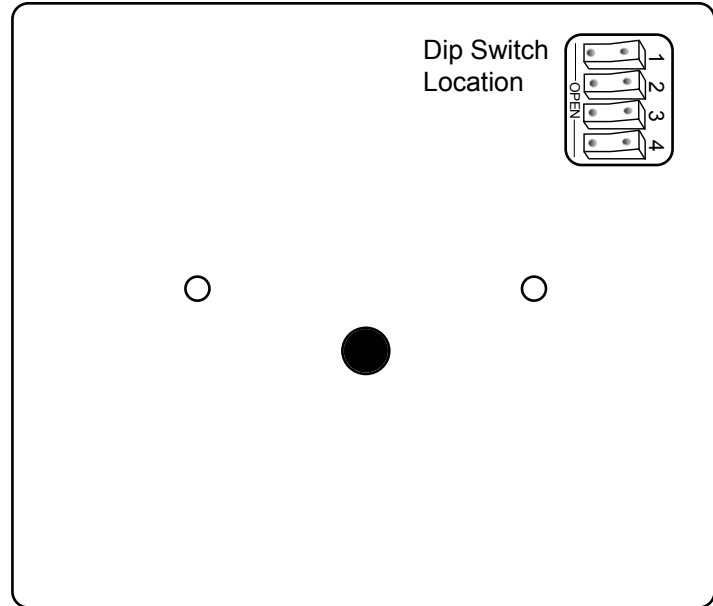

Fig. 4: Rear Panel of Timer

NOTE:

Dip switch settings are to be selected PRIOR to connection of power source and programming of all other timer functions.

WEBASTO DBW SERIES HEATERS _____ OPERATING INSTRUCTIONS.

Switch 1 & 2 control timer on duration.

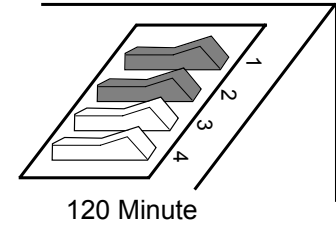
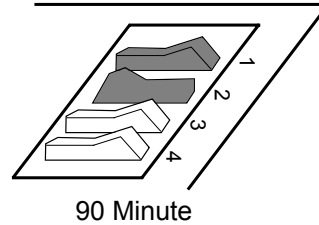
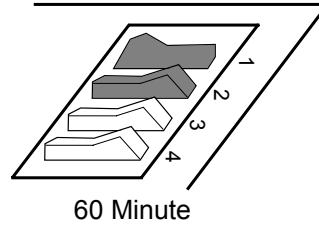
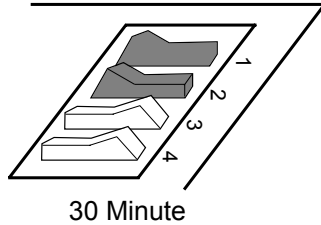

Switch 3 controls truck vs. bus operation.

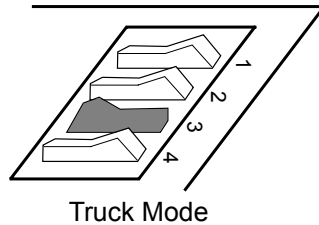
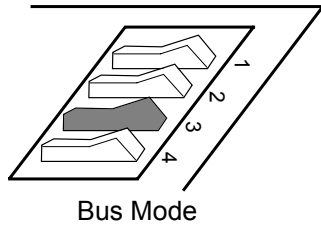

Switch 4 controls 12 vs. 24 hour clock.

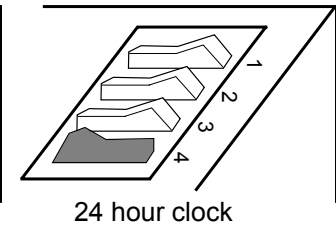
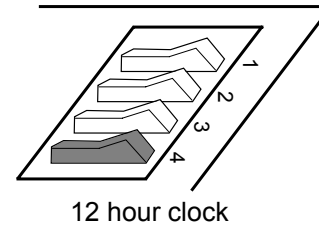

Default settings for new timers are:

- Truck - 60 minute operation time, 12 hour clock
- Bus - 60 minute operation time, 12 hour clock

WEBASTO DBW SERIES HEATERS _____ OPERATING INSTRUCTIONS

Setting the Electronic Timer (Model CDN-1224)

- 1 Time Display
- 2 Heater on/off indicator LED (green)
- 3 Timer active status LED (yellow)
- 4 Clock time status LED (red)
This LED will be on during PM time when AM/PM dip switch setting is selected
- 5 Days of the week LED's (red)
- 6 Function buttons

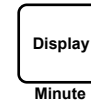
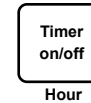
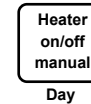
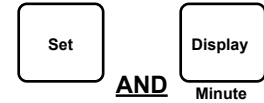

Fig. 5: 7-Day Electronic Timer Model CDN-1224

WEBASTO DBW SERIES HEATERS _____ OPERATING INSTRUCTIONS

Clock Programming (Present Time and Day)

- Depress buttons 'Set' and 'Display' simultaneously to start programming
NOTE: Time display will begin to flash.
- Depress button 'Day' to select day of week.
- Depress button 'Hour' to select correct hour.
NOTE: If the dip switch setting is in the AM/PM mode, the red PM LED will respond.
- Depress button 'Minute' to select correct minute.
- Depress button 'Set' to end timer programming.
NOTE: If 'Set' button is not depressed within 15 seconds, programming function will end automatically.



WEBASTO DBW SERIES HEATERS _____ OPERATING INSTRUCTIONS

Timer Programming (Timed Heater Start Setting)

- Depress buttons 'Set' and 'Timer on/off' simultaneously to start programming.
NOTE: The yellow 'T' LED will flash
- Depress button 'Day' to select day heater is to come on.
- Depress button 'Hour' to select correct hour.
- Depress button 'Minute' to select correct minute.
- Depress button 'Set' to end timer programming.
NOTE: If 'Set' button is not depressed within 15 seconds, programming function will end automatically

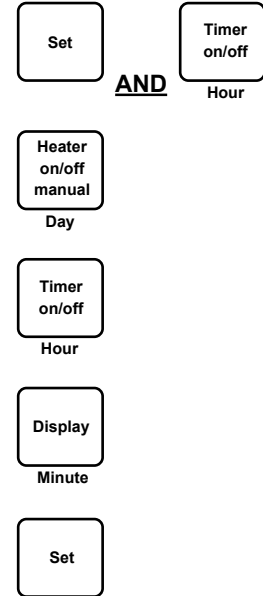

WEBASTO DBW SERIES HEATERS _____ OPERATING INSTRUCTIONS

Timer Operation (Model CDN-1224)

Manual Operation

To manually turn the heater on, press the heater on/off manual button. The heater on/off indicator LED (green) will come on. Press this button a second time to turn the heater off.



Day

Timer Operation

Depress the timer on/off button to activate or deactivate the timer. If the timer is active, the timer status LED (yellow) will light and the heater will come on when the next timing program is reached. The tables on page 17 depicts the performance of the timer based upon truck or bus operation.



Hour

Display Stand By Mode

To save battery life, the display will go blank after about 5 minutes if there is no activity. To reactivate the display, press the DISPLAY button.



Minutes

WEBASTO DBW SERIES HEATERS _____ OPERATING INSTRUCTIONS

Maintenance of the Heater

To ensure functional reliability of the heater the following maintenance must be performed:

- check combustion air inlet and exhaust outlet for contamination and clean as required.
- outside the heating season the heater should be operated with the vehicle engine cold approximately every four weeks for 20 minutes setting the heating system to "warm" and opening all appropriate coolant flow control valves. This avoids difficulties in the startup at the beginning of the heating season and prolongs heater motor and bearing life.
- after replacing the coolant of the vehicle engine ensure proper bleeding of the heater after bleeding the vehicle cooling system. Start the vehicle engine and turn OEM heater system on in full heat mode. Switch on heater circulation pump (if separate switch is available) or operate heater for 5 seconds to run circulation pump using rundown cycle. Repeat procedure as required until warm air comes out of heating ducts. Replenish coolant to manufacturer's instructions if level is low.
- before the heating season (point of time when weather conditions cause increased use of equipment) the fuel filter or filter cartridge must be replaced to prevent malfunctions.
- the heater should be checked on regular intervals by a Webasto service agent, the latest before the beginning of the heating season.

Basic Troubleshooting

CAUTION

Troubleshooting requires profound knowledge about structure and theory of operation of the heater and components. Troubleshooting and fault correction should only be performed by Webasto trained, skilled personnel unless otherwise stated in this manual.

General Information

This section describes troubleshooting procedures for DBW Series coolant heaters. Troubleshooting is normally limited to the isolation of defective components.

Before troubleshooting, check for and eliminate the following defects:

- fuel supply (plugged fuel filter, kinked fuel line)
- corrosion on battery terminals
- blown fuses
- corrosion on electrical wiring, connections and fuses
- loose contacts or improper crimping on connectors
- shut down initiated by temperature limiter thermostat (automatic reset)
- shut down initiated by overheat fuse

WEBASTO DBW SERIES HEATERS _____ BASIC TROUBLESHOOTING

Malfunctions

The DBW Series of coolant heaters are designed with automatic, self-monitoring systems that will shut the heater off in the event of a problem.

The heater will switch itself off automatically if combustion does not start after the heater has been switched on, or if the flame goes out, or if the heater overheats. The operation indicator light will go out to signify a problem.

The following steps can be taken to determine and correct obvious problems.

If the operation indicator light does not come on at the same time as the heater is switched on, check and, if necessary, replace fuse (F2). If the operation indicator light comes on when the heater is switched on, but goes out after about 30 seconds, check and, if necessary, replace fuse (F3).

NOTE:

In most heater models, the fuses referred to in the above paragraph can be located on the back wall of the heater enclosure or are tray. Some models may also utilize a 30 amp. main fuse at the battery connection.

If overheating has occurred, locate and correct the problem. On the DBW 2010 Arctic, DBW 2020 and DBW 300 series heaters, it may be necessary to replace the overheat melt fuse located under the thermostat cover on top of the heater. The fuse can be identified by the two white wires protruding from its top. The fuse is screwed hand tight into a dry well plug. Do not over tighten the fuse when replacing. On all other DBW 2010 heaters not equipped with an overheat fuse, simply correct the cause of overheating and allow the heater to cool down.

If a lock-out condition occurs due to a malfunction, this condition can be cleared and the control unit reset by switching the heater off and switching it back on again. If the heater goes to lock-out once again after correcting all obvious problems, consult your nearest Webasto Service Station.

Malfunction Identification - DBW Series Heaters

This table is intended to assist the swift diagnosis of simple malfunctions, which have obvious symptoms. It cannot replace the detailed knowledge of an expert workshop. For assistance, please contact one of the workshops recommended in the list of service stations.

PROBLEM		CHECK, REPAIR OR REPLACE IF NECESSARY																
		Check Voltage Supply	Electrical Fuse	Electrical Switch	Overheat Fuse or Connection	Control thermostat	Flame detector	Control Unit	Ignition Electrodes	Ignition Coil - Coil Wire	Electric Motor	Fuel Supply	Fuel Pump	Fuel Solenoid Valve	High Pressure Nozzle	Coolant Circulating Pump	Exhaust Air Intake	Heating System
Switch On	No Function	•	•	•	•	•												
Control Light	OFF after 30 Seconds					•	•	•	•	•	•	•	•	•				
Blower Motor in Unit	Does Not Run	•	•	•		•		•										
Blower Motor in Unit	No Prime Cycle	•						•										
Blower Motor in Unit	No After Run							•										
Coolant Circulation Pump	Does Not Run	•	•	•				•		•								
Ignition Spark	Absent		•	•				•	•									
Combustion	Does Not Take Place				•			•	•	•		•	•	•				
Combustion	Stops after 30 Seconds	•		•				•	•									
Combustion	Cannot Be Stopped				•			•					•					
During Combustion	Light Color Smoke									•	•		•					
During Combustion	Dark Color Smoke	•		•						•	•				•	•		
Heating Unit	Overheating		•			•		•						•				•

Table 2: Quick Check Matrix

WEBASTO DBW SERIES HEATERS _____ BASIC TROUBLESHOOTING

Sequence of Events - DBW Series Heaters

The normal sequence of events illustrated here may be used in conjunction with the malfunction identification table to help determine heater problems.

Table 3: Sequence of Events

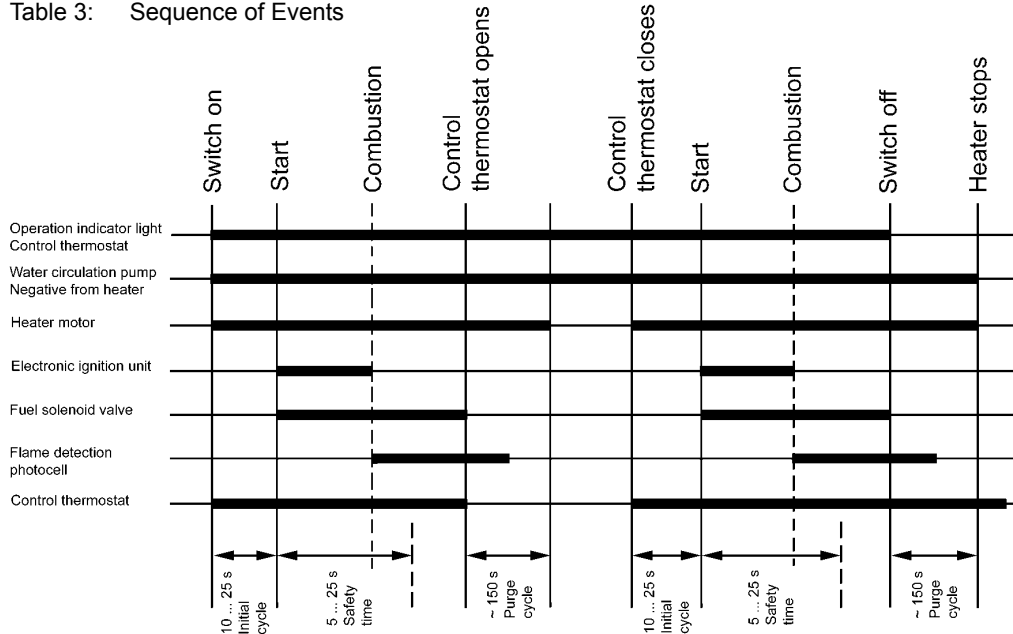

NOTE:
 After the correction of a malfunction, a functional test must always be performed with the heater installed in the vehicle in its operational position.

Technical Data

General Information

Where no threshold values are specified, technical data are understood to include standard tolerances for heater units of $\pm 10\%$ at ambient temperature of $+ 20\text{ }^{\circ}\text{C}$ ($+ 68\text{ }^{\circ}\text{F}$) and at nominal voltage.

Electrical components:

Control unit, fan and circulation pump motors, solenoid valve, igniter box, heater cartridge, nozzle pre-heater and timer are voltage sensitive components. Temperature limiter, overheat fuse, control thermostat, flame sensor and switches are voltage independent components.

Heater Data

Refer to adjacent table

Heater	DBW 2010	DBW 2020	DBW 300
Mark of conformity	~ S 129	~ S 136	~ S 164
Heater design principle	High pressure fuel atomizing nozzle		
Heat output kW/h (BTU/h)	13.1 (45,000)	23.3 (80,000)	30 (104,000)
Fuel	Diesel #1, Diesel #2, Arctic grade and Kerosene		
Maximum fuel consumption l/h (US gal/h)	1.5 (0.4)	3.0 (0.79)	4.0 (1.05)
Rated nominal voltage V	12 or 24		
Operating voltage V	10 ... 14 or 20 ... 28		
Nominal power consumption (without circulation pump) W	60	120	130
Permissible operating ambient temperature range (heater, control unit, circulation pump) $^{\circ}\text{C}$ ($^{\circ}\text{F}$)	- 40 ... + 60 (- 40 ... + 140)		
Permissible storage temperature $^{\circ}\text{C}$ ($^{\circ}\text{F}$)	+ 85 max. (+ 185)		
Permissible operating pressure of coolant system bar (psi)	0.4 ... 2.0 (06 ... 29)		
Minimum capacity of circuit l (US. Gal)	10.00 (2.64)		
CO ₂ in exhaust at nominal voltage Vol.-%	10.5 ... 11.0		
CO in exhaust at nominal voltage Vol.-%	0.2 maximum		
Dimensions of heater	length mm (in.) width mm (in.) height mm (in.)	584 (23") 205 (8-1/6") 228 (10")	680 (26-23/32") 240 (9-1/2") 279 (10-29/32")
Weight (without enclosure)	15 kg (33 lbs.)		22 kg (48 lbs.)

Table 4: Heater Data

U 4810 and U 4846 Coolant Pump Data

Recommended coolant circulation pumps for DBW 2010 heaters.

Coolant Circulation Pump		U 4810	U 4846
Volume flow	l/h (US. Gal/min)	1600 (6.0) @ 0.15 bar	1650 (7.0) @ 0.15 bar
Nominal voltage	V	12 or 24	12 or 24
Operating voltage range	V	10 ... 14 or 20 ... 28	10 ... 14 or 20 ... 28
Nominal power consumption	W	25	28
Dimensions of coolant circulation pump	length	173 mm (6.8 in.)	128 mm (7.16 in.)
	width	94 mm (3.7 in.)	94 mm (3.7 in.)
	height	77 mm (3.0 in.)	82 mm (3.32 in.)
Hose connection	O.D.	38.0 mm (1.5 in.)	20.0 mm (0.78 in.)
Weight	kg (lb.)	2.1 (4.63)	0.85 (1.88)

Table 5: U 4810 & U 4846 Coolant Pump Data

NOTE:

The allocation of circulation pumps to heater units must be in accordance with coolant resistances.

WEBASTO DBW SERIES HEATERS TECHNICAL DATA

U 4814, U 4851 and U 4852 Coolant Pump Data

Recommended coolant circulation pumps for DBW 2020 and DBW 300 heaters.

Coolant Circulation Pump		U 4814	U 4851 & U 4852
Volume flow	l/h (US. Gal/min)	5200 (22.9) @ 0.15 bar	6000 (26.4) @ 0.4 bar
Nominal voltage	V	12 or 24	24
Operating voltage range	V	10 ... 14 or 20 ... 28	18 ... 32
Nominal power consumption	W	104	209
Dimensions of coolant circulation pump	length	221 mm (8.7 in.)	285 mm (11.22 in.)
	width	100 mm (3.94 in.)	115 mm (4.52 in.)
	height	105 mm (4.14 in.)	110 mm (4.33 in.)
Hose connection	O.D.	38.0 mm (1.5 in.)	38.0 mm (1.5 in.)
Weight	kg (lb.)	2.1 (4.63)	2.7 (5.95)

Table 6: U 4810 & U 4846 Coolant Pump Data

NOTE:

The allocation of circulation pumps to heater units must be in accordance with coolant resistances.

WEBASTO DBW SERIES HEATERS _____ NOTES

NOTES



Webasto Product N.A., Inc.

15083 North Road
Fenton, MI 48430

Technical Assistance Hotline

USA: (800) 555-4518

Canada: (800) 667-8900

www.webasto.us

www.techwebasto.com